

# MEA® RIN

A class apart

Light

Cost Effective

Resistant



- > MEA® RIN Plus
- > MEA® RIN Expert

# MEARIN®

## A class apart

### Facts

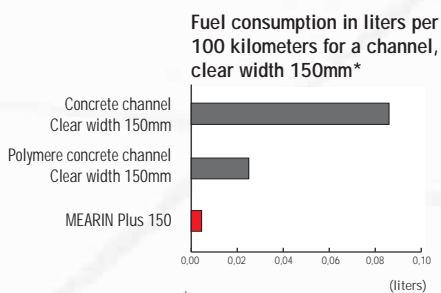
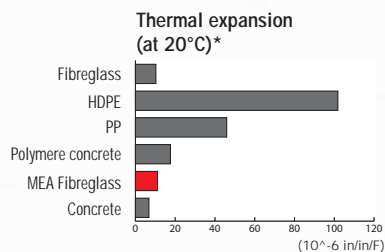
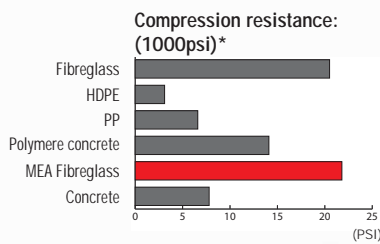
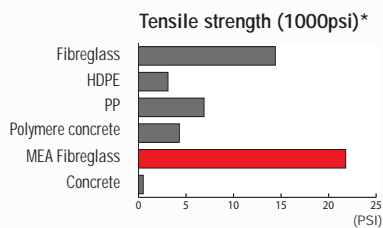
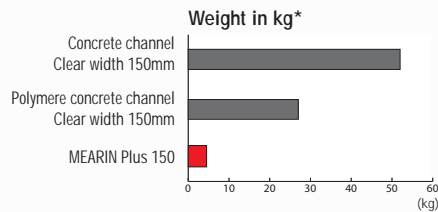

\* The values given are averages

### Lightweight | High Performance | Minimum Cost

- > Allows installation of channels without mechanical support and with significantly less labour than with comparatively heavy polymer concrete or concrete channels. Depending on the individual installation application, between 15% and 42% of time and labour costs can be saved.
- > Despite its minimal weight, in contrast to most of the PP and PE and GRP trench drain, loading classes up to E600 are possible.
- > The innovative STARFIX quick fastener ensures quick and easy assembly and disassembly of the grates, and uncomplicated cleaning of gutters.
- > Reduces transport costs and protects the environment. The transport of comparable polymer concrete channels per 100 kilometres uses on average 5 to 6 times more fuel. While for concrete channels, about 18 to 20 times more fuel is required than with the extremely light MEARIN channel bodies.

### Outstanding Value | Maximum Stability | Minimal Effort

- > Great variability in the application up to loading class E600
- > High breaking strength and abrasion resistance of the channel body and the surface
- > Perfect anchorage of the system in the concrete shell and thus increased stability
- > Long life and minimal maintenance



Intensive research and maximum quality standards guarantee excellent MEA GRP products.

## The Material at a Glance

- > Great resistance to chemicals, oils and other aggressive media
- > Extreme stability against weathering
- > Minimum weight
- > Low transport costs
- > Conserves resources and is environmentally sustainable

Thanks to the long fibres MEA GRP has an extremely high breaking strength and resistance, combined with great flexibility of the channel body

## The Premium Material

All MEARIN channel systems are manufactured from the innovative MEA GRP. GRP stands for glass reinforced plastic and is used in a wide range of applications with high demands, such as aircraft, the automotive industry and in racing.

Not all GRP is the same, however. Quality and specific properties differ, sometimes considerably. We rely on the SMC technology (Sheet Molding Compound) – a composite of polyester resin, mineral fillers, additives, and glass fibre mats. SMC has the highest strength and dimensional stability. Providing extremely stability even at high temperature fluctuations, combined with a very low thermal expansion.

Unlike thermoplastics, SMC does not deform after hardening, but remains stable and durable in shape. Our extensive experience and expertise with this material guarantees lightweight and durable products that create added value.

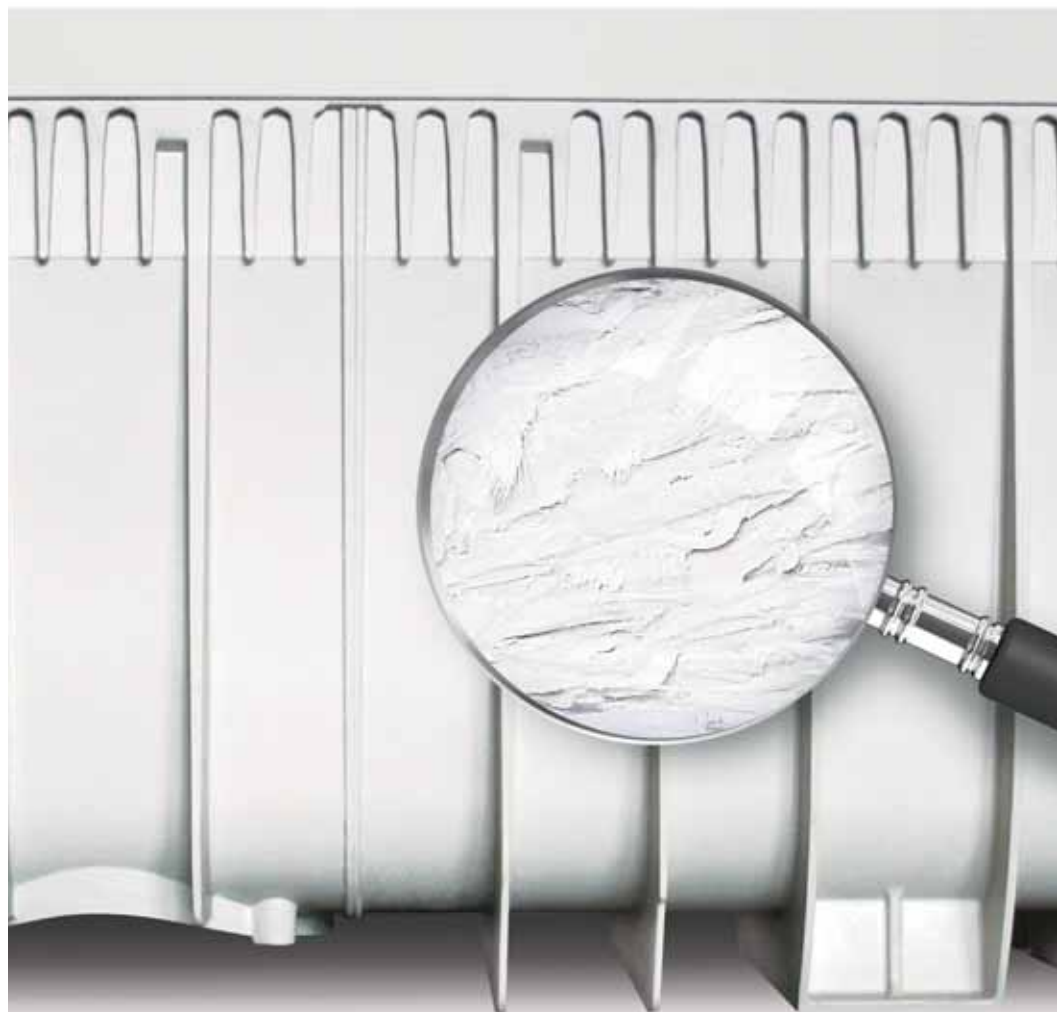

# MEA®RIN Plus

## Channel system with *fibreglass Edge*

- > Channel body and edge entirely of UP-GF (unsaturated polyester - glassfibre -reinforced)
- > Available in nominal widths 100, 150, 200 and 300
- > Steel, ductile iron and plastic grating options
- > Application fields: Public places, parking, lots, garden and landscape design
- > Slope possible in all nominal widths with innovative plug-on edge
- > Loading class to D400

## MEA®RIN Plus

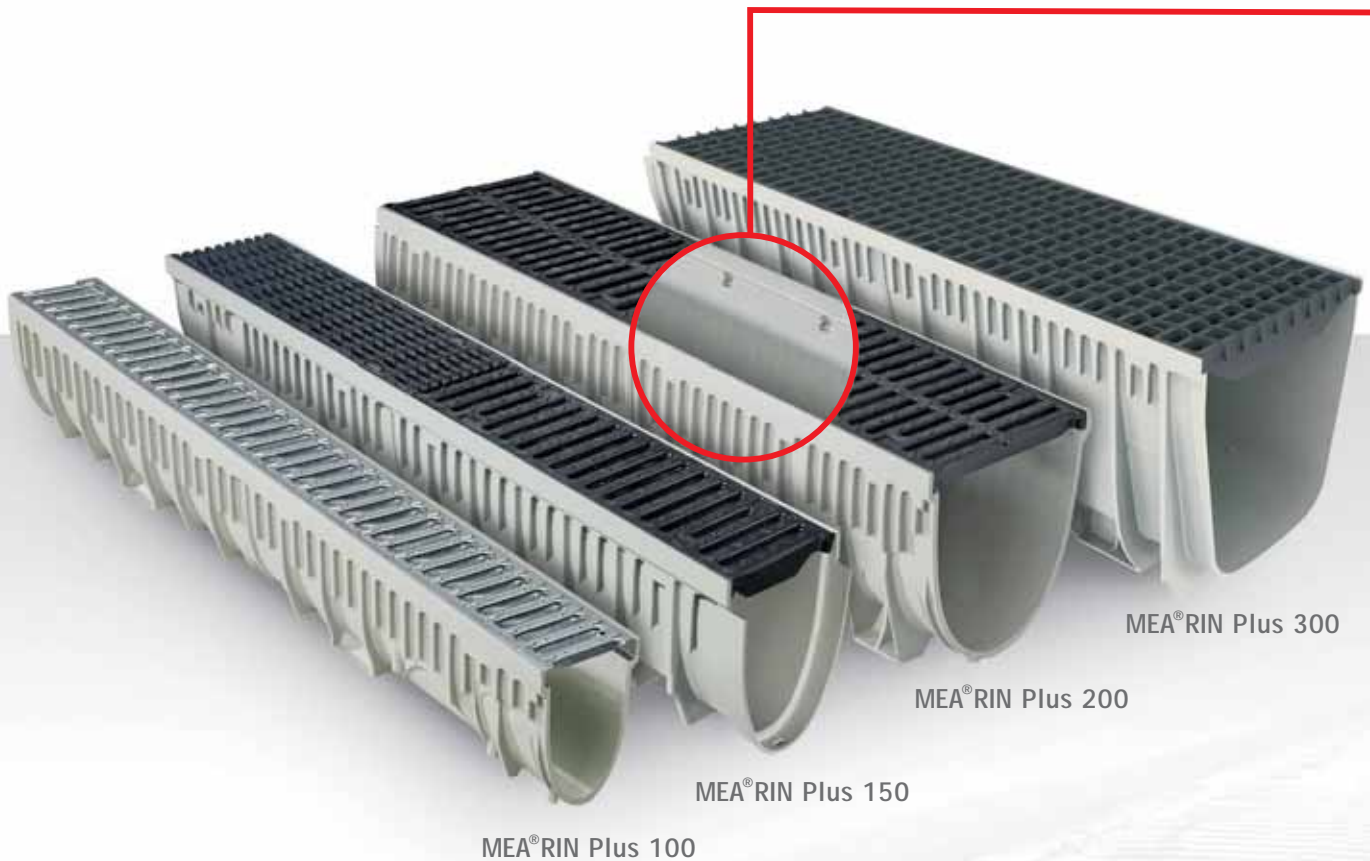

# MEA®RIN Expert

channel system with edge  
made of *galvanized steel*

- > Channel body of UP-GF (unsaturated polyester - glass-fibre reinforced) with firmly integrated edge protection made of galvanized steel for high loads
- > Available in nominal widths 100, 150, 200 and 300
- > Steel, ductile iron and plastic grating options
- > Application fields: leisure parks, industrial areas, workshops, roads and traffic routes
- > Loading class up to E600

## MEA®RIN Expert



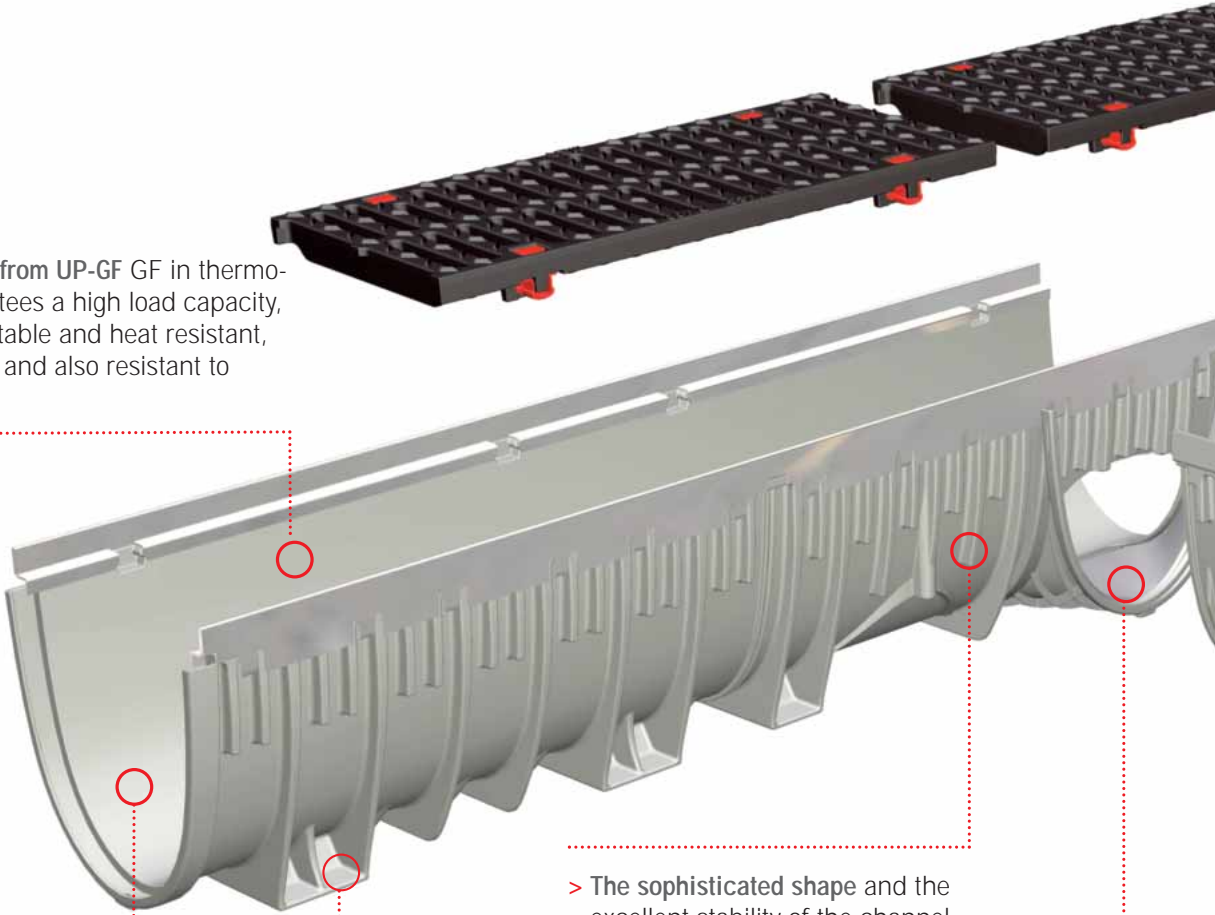

> The channel body from UP-GF GF in thermo-set quality guarantees a high load capacity, is dimensionally stable and heat resistant, abrasion resistant and also resistant to chemicals.

> The optimized channel shape provides improved drainage capacity at low water levels and makes for a good self-cleaning effect.

> The sophisticated shape and the excellent stability of the channel bodies allows a broad range of solutions up to the drainage load class E600.

> The broad and deep anchorage compartments guarantee a permanently secure hold in the concrete bed.

> The innovative STARFIX grating secure system speeds installation and maintenance. This saves time and money. The 4-point lock prevents loose or rattling grates and prevents longitudinal displacements. No bolts or special tools needed to assemble and disassemble grates with the flick of a wrist. It has never been so simple and fast.

> MEA®RIN: Certified compliant with EN 1433 and CE

> Standardized and good: First complete and sealable trench drain system made of UP-GF

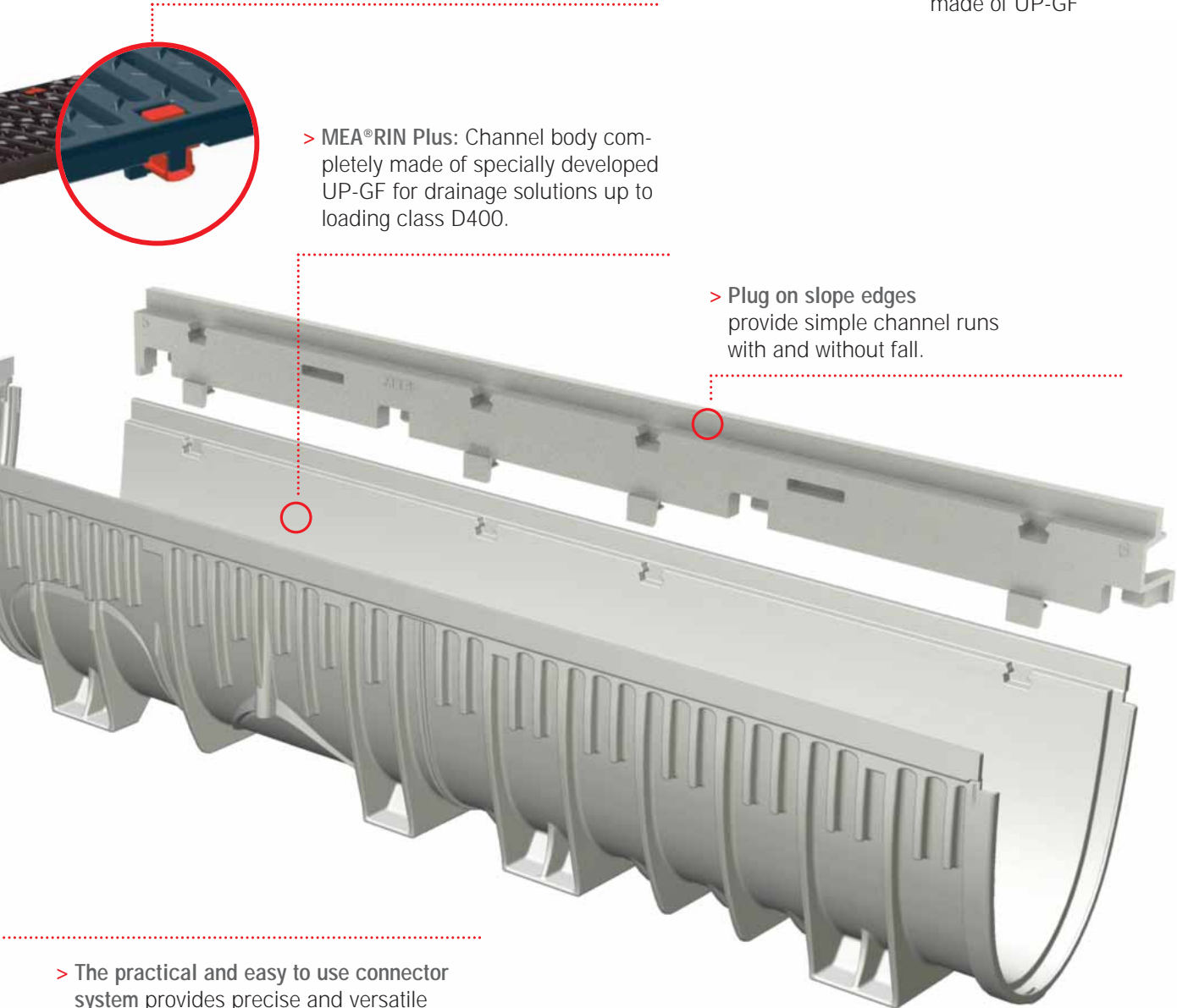

> MEA®RIN Plus: Channel body completely made of specially developed UP-GF for drainage solutions up to loading class D400.

> Plug on slope edges provide simple channel runs with and without fall.

> The practical and easy to use connector system provides precise and versatile mounting variations.

#### Loading classes:

A 15	B 125	C 250	D 400	E 600
<ul style="list-style-type: none"> <li>• Pedestrians</li> <li>• Cyclists</li> <li>• Green areas</li> </ul>	<ul style="list-style-type: none"> <li>• Passenger car parking lots and parking decks</li> <li>• Delivery vans</li> </ul>	<ul style="list-style-type: none"> <li>• Trucks</li> <li>• Hard shoulder</li> <li>• Verge</li> </ul>	<ul style="list-style-type: none"> <li>• Roadways</li> </ul>	<ul style="list-style-type: none"> <li>• Industrial areas</li> </ul>

# MEARIN<sup>®</sup> Plus

With the MEARIN Plus plug in edge channel runs with base fall 0.5%, combined with runs without fall can be easily realized.

The edges are simply clipped onto the channels and no screws, drilling or permanent fixing is required. The resulting compound can withstand high loads and provides maximum flexibility.

## Overview MEARIN<sup>®</sup> Plus slope edges:

- > Simple and easy installation
- > Low weight edges, between 0.9 to 1.4 kg per edge
- > Significant increase in drainage capacity
- > Heights of the channel bodies including edges from 195mm to 240 mm
- > Fall 0.5% on 1 metre channel run
- > Available for MEARIN Plus systems 100/150/200 and 300
- > Also available for catch basins
- > Each available for right and left channel side

## Plug in edges

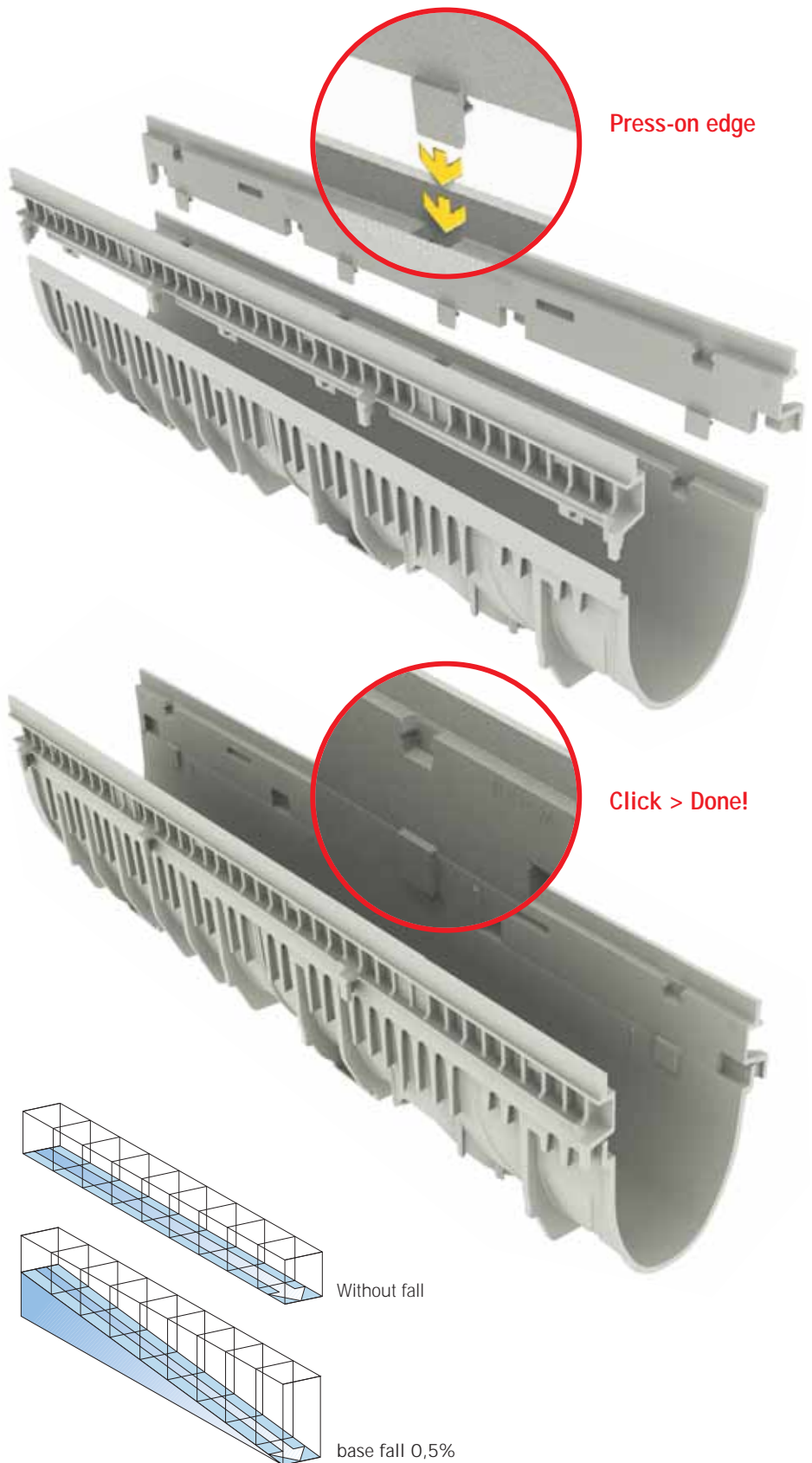



# STARFIX

## The innovative grating system without bolts



Press!

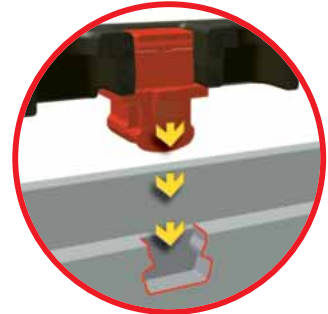

Click!



Done!

- > Innovative 4-point locking inside the channel body for a solid and secure fit, without any loose or rattling parts
- > Protection against longitudinal displacement of grating covers
- > Long service life, as no movable parts or parts subject to wear
- > No reduction of the discharge cross-section, as the complete channel cross section remains unobstructed
- > Simple and fast insertion and removal of gratings with a single hand movement – without the need for special tools
- > Particularly pleasant and quiet thanks to a noise reducing closure making it ideal for low traffic or noise-protected zones.

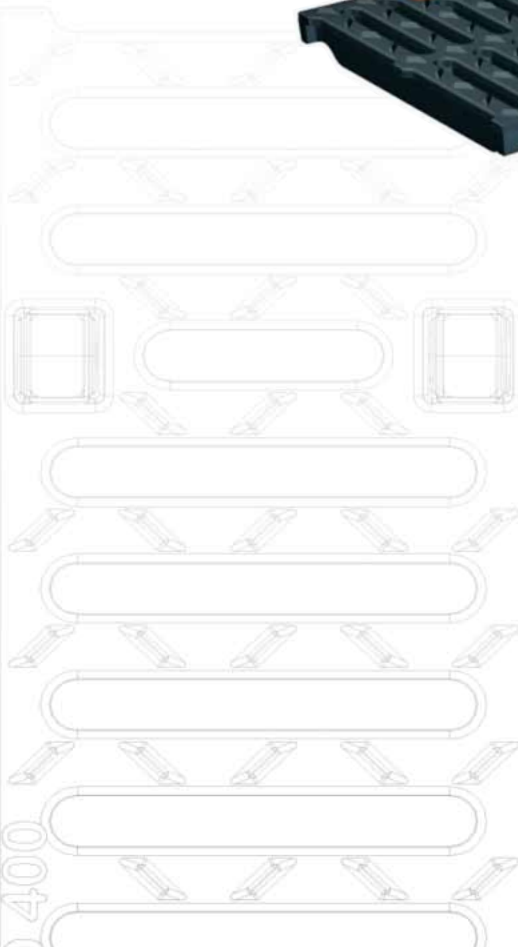

The patented STARFIX system is the innovative turbo for grate securing. It was never so quick and easy before: without bolts or special tools all grating types can easily be fastened or loosened with the flick of a wrist:

### **Press! Click! Done!**

The rugged 4-point fastening reliably prevents loose or rattling grates and provides a robust protection against longitudinal displacement.

In addition, the channel cross-section is completely free, so that the drainage capacity is not diminished. Even the look of STARFIX is sleek:

the flush finish with the channel edge in all grating types makes for an attractive drainage solution that does not need to be hidden.

## Gratings



Slotted grating galvanized steel



Plastic-slotted grating



Ductile iron slotted grating

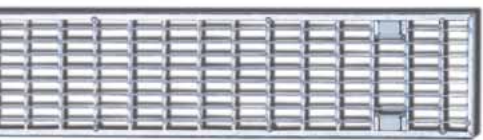

Mesh grating galvanized steel

MEA offers a wide range of covers for the MEARIN system that are not only functional, but also set standards in product design.

From efficient mesh gratings to the the classical slotted gratings, up to the elegant design gratings, the name MEA stands for quality, innovation and creativity.

- > **Slotted gratings in galvanized steel or plastic:**  
The intelligent web / slotted design is an optical alternative to mesh grids. Particularly stable and durable.  
For loading classes A15 to C250
- > **Ductile iron slotted gratings:**  
Especially suitable for extreme loads and high traffic areas. For loading classes C250 to E600
- > **Mesh gratings:**  
The classical channel cover made of galvanized press grating. For loading classes A15 to D400
- > **Design gratings in stainless steel and galvanized steel:**  
Five different designs for clear width 100.  
Loading class A15.

### DESIGN GRATINGS:



"SPOT"



"RAYS"



"RALLYE"



"LOZENGE"



"FISH"

## Sustainable solutions for agricultural areas



Particularly in the drainage of agricultural areas, silos or composting, problems associated with cuttings, straw or other materials often occur, which accumulate in the channel body and strongly reduce the drainage capacity. MEA offers an efficient, cost effective and easy to maintain solution.

Before installing the grates, a commercially available PE-HD pipe with a slot width of 1.2 mm can be inserted into the MEARIN Plus channel systems. After commissioning of the plant, the small parts accumulate on the pipe, and the water flow is still guaranteed. With the usual maintenance work the system can be cleaned after removal of the grates with a screwdriver. By using MEARIN Plus channels with STARFIX, covers without galvanized parts and fittings, the system is permanently resistant to fluid build up in the silos.

### At a glance

- > Suitable for biogas and composting plants, silos and other farm areas
- > Project-specific support provided by the MEA sales and qualified application engineers
- > No use of galvanized parts in cover and channel bodies
- > Quick cleaning of the system
- > Permanently guaranteed drainage capacity



In agricultural areas small particles, such as straw, silage, etc. can get stuck in the slots of the mesh grids.

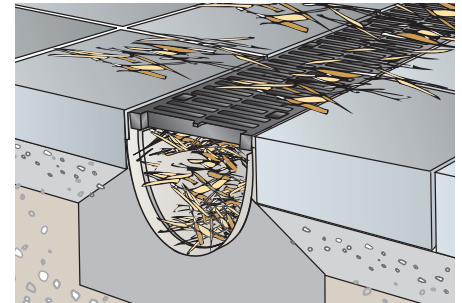

Contamination of the channel by these particles and impairment of the drainage capacity occurs.

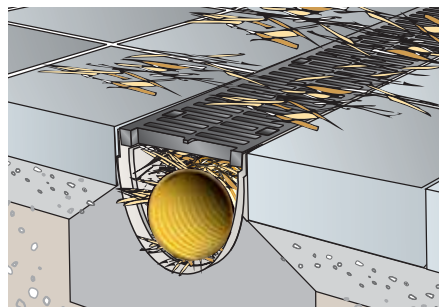

MEARIN 100 Plus channel with HD-PE pipe prevents these particles from getting inside the tube and the drainage is ensured.

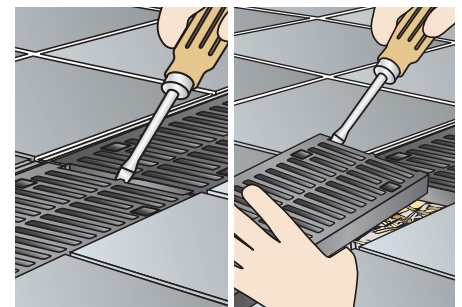

Easy removal of the grating  
 Step 1: Placement of the screwdriver on the joint of the grating  
 Step 2: Lifting out of the grating

# MEA® RIN

## A class apart

### Minimum weight for

- > faster installation
- > economical shipping

### Practical plug in system for

- > precise assembly

### Sophisticated system with

- > a wide range of accessories for easy install

### Extreme stability for

- > loading to class E 600

### Optimum channel cross section for

- > maximum drainage capacity

### Modern material for

- > high temperature and chemical resistance e.g. against oil, fuel, hot asphalt, sewage and tartaric acid

### Innovative competent support team

- > for individual solutions with proximity to market

For enquiries in the UK and Ireland:

**MEA UK Limited**  
Rectors Lane  
Pentre  
Deeside  
Flintshire  
CH5 2DH  
Phone: 0 1244 53 44 55  
Fax: 0 1244 53 44 77  
uk.technical@mea.de  
www.mea-group.com

**MEA Water Management GmbH**  
Industriestraße 8  
D-86551 Aichach-Ecknach  
Telefon: +49 (0) 8251 - 91 0  
Telefax: +49 (0) 8251 - 91 13 00  
E-Mail: info.drainage@mea.de  
www.mea-group.com  
www.mea-drainage.com

